

# Operating Manual

## Frequency Converter FU3AM-03

Digital frequency inverter for stepless speed control  
of asynchronous-three-phase a.c. motors



Operating Manual

Frequency inverter  
FU3AM-03

Document

R0086EGB.doc

Version

05/13

**Contents:**

	Page
<b>1. PREFACE AND GENERAL</b>	<b>5</b>
1.1 BRIEF DESCRIPTION	5
1.2 ADVANTAGES:	5
1.3 EXTEND OF DELIVERY	5
1.4 DISCLAIMER	6
1.5 DEFINITIONS	6
<b>2. SAFETY</b>	<b>7</b>
2.1 OPERATING MANUAL	7
2.2 SYMBOLS	7
2.3 GENERAL SAFETY INFORMATION	7
2.4 OPERATOR RESPONSIBILITIES	8
2.5 PERSONNEL	8
2.6 INSTRUCTIONS ON UNPACKING, MOUNTING AND INSTALLATION	8
2.7 ELECTRICAL INSTALLATION	9
2.8 INFORMATION ON EMC	10
2.9 OPERATION OF THE FREQUENCY INVERTER	11
2.10 IMPORTANT INSTRUCTIONS ON PROTECTIVE EARTHING	11
2.11 IMPORTANT INSTRUCTIONS ON ROUTING OF WIRES	11
<b>3. TECHNICAL DATA</b>	<b>12</b>
3.1 TECHNICAL DATA FU3AM	12
3.2 LIMITING VALUES	13
3.3 REDUCTION OF POWER	13
3.4 DIMENSIONS	14
<b>4. DESCRIPTION OF CONNECTION</b>	<b>15</b>
4.1 ALL CONNECTIONS AT A GLANCE	15
4.2 CLAMP ASSEMBLY	16
CONNECTER DESCRIPTION	16
4.3 MOTOR CONNECTION PLUG X1 TO TOP OF DEVICE	17
4.4 MOTOR CONNECTION PLUG X2 TO BOTTOM OF DEVICE	17
4.5 CONNECTION MAINS PROTECTION X3 TO TOP OF DEVICE	17
4.6 CONTROL CONNECTION X4	18
4.7 DIGITAL 10-BIT SET VALUE PARALLEL INPUT X5	20
4.8 BRIDGE CONNECTOR FOR ONE-FAULT SAFETY	20
<b>5. COMMISSIONING</b>	<b>21</b>
5.1 SWITCH-ON SEQUENCE	21
5.2 DISPLAY	21
<b>6. SERVICE INFORMATION</b>	<b>23</b>

---

<b>6.1 SUMMARY OF PARAMETERS</b>	<b>23</b>
<b>6.2 CONFIGURATION UND USEFUL INFORMATION ON PARAMETERS</b>	<b>24</b>
6.2.1 MODE	24
6.2.2 CHARACTERISTIC CURVE	25
6.2.3 SET POINT ADAPTATION, FIXED SET POINTS AND RAMPS	25
6.2.4 AUTOMATIC RESET	26
6.2.5 MOTOR TEMPERATURE MONITORING	26
6.2.6 FAN CONTROL	26
6.2.7 OPERATING HOURS COUNTER	26
6.2.8 OVERCURRENT CUT-OFF	26
<b>7. FINDING AND ELIMINATING FAULTS</b>	<b>27</b>
7.1 RESETTING FAULTS	27
7.2 POSSIBLE CAUSES OF FAULTS	27
<b>8. OPERATING SOFTWARE</b>	<b>28</b>
8.1 UNIDESK	28
8.2 SERIAL INTERFACE	28
<b>9. REVISION INDEX</b>	<b>29</b>
9.1 DOCUMENTATION	29
9.2 DEVISE	29
<b>10. INDEX</b>	<b>30</b>

-Errors and omissions excepted, subject to alterations-

ANTEK GmbH  
Im Köchersgrund 1  
71717 Beilstein



+49 7062 94060



+49 7062 940620



info@antek-online.de



www.antek-online.de

## 1. Preface and general

### 1.1 Brief description

Digital frequency inverter for stepless speed control of asynchronous three-phase AC motors with numerous features, such as:

- ◆ Wide range voltage input
- ◆ Input-side mains filter already integrated
- ◆ digital tachometer feedback (optional)
- ◆ Temperature monitoring of output stage
- ◆ Phase current monitoring of the motor winding
- ◆ Input for any number of motor temperature sensors
- ◆ Over- and under voltage monitoring of intermediate circuit
- ◆ Levelling of intermediate circuit fluctuations
- ◆ Act./Nom. monitoring of speed in controller mode
- ◆ Aluminium profile housing for switch cabinet mounting
- ◆ Plug-type connecting terminals (screw-in or spring-loaded push-in connector)
- ◆ Integrated switching power supply

### 1.2 Advantages:

- ◆ Compact and space-saving type
- ◆ Excellent control properties over a broad control range
- ◆ Versatile possibilities for set value specification:
  - ◆ Through analogue voltage
  - ◆ By means of programmable fixed speeds
  - ◆ Over digital control word
- ◆ Reliable mains separation through integrated mains protection (with external activation, with signalling contact)
- ◆ Operation with industry standard motors
- ◆ Sinusoidal excitation of the motor ensures that the latter runs true run even at low speeds
- ◆ Potential-free electronics
- ◆ Overload-proof protection
- ◆ Change direction of rotation by electronic system
- ◆ Short launch times when using prefabricated and pre-inspected cable sets.
- ◆ Service-friendly connection technology
- ◆ Display shows every device status at a glance
- ◆ Well-arranged device programming with ANTEK UniDesk
- ◆ PC interface: standard-compliant RS 232 jack
- ◆ Interference suppression class "A"
- ◆ UL-CSA-Approbation

### 1.3 Extend of delivery

Frequency inverter for insertion in control cabinet . The frequency inverter has been tested for correct functioning and continuous operation.

## 1.4 Disclaimer

### Liability

The information, data and instructions contained in this operating manual were up-to-date as of the date of publication. No claims may be made in respect of inverters delivered previously on the basis of statements, illustrations/photos or descriptions contained in this operating manual.

The process-specific instructions and circuit extracts contained in this manual are recommendations. Their applicability to the task in hand must first be verified.

The firm ANTEK GmbH assumes no liability for the suitability of the processes described and the suggested circuits contained herein.

No liability will be assumed for damages or malfunctions caused by:

- ◆ disregarding this operating manual
- ◆ unauthorized modifications made to the inverter
- ◆ operator errors
- ◆ improper working on and with the inverter
- ◆ Operation of the inverter in mountings or connections, other than those described in this manual.

### Warranty

Warranty claims are to be made to the manufacturer as soon as a fault / defect is discovered. The warranty will be voided by:

- ◆ improper use of the inverter
- ◆ improper working on and with the inverter
- ◆ arbitrary modifications to the inverter

## 1.5 Definitions

### Qualified Personnel

Qualified personnel are persons who, due to their training, experience and instructions, as well as their knowledge of relevant standards and directives, safety-regulations, company policies, and entitled by those responsible for the safety of the system, are justified to carry out necessary tasks and recognize and avoid possible dangers.

(Definition for qualified employees per IEC 364)

### Operator

An operator is any natural person or legal entity who operates the inverter, or in whose name the frequency inverter is operated.

## 2. Safety

### 2.1 Operating Manual

This operating manual contains safety instructions for correct operation on and of the frequency inverter, they are to be followed.

In addition to the general safety instructions contained in this chapter, the instructions contained in the manual text must also be followed.

No claim is made that the safety instructions are complete. Please contact the manufacturer in the event of questions or problems.

This manual must be available to all persons who work on or with the frequency inverter and must remain in good, readable condition.

### 2.2 Symbols

In these instructions important explanations are highlighted with the following symbols:



Caution: this explanation indicates hazards which, under certain circumstances, may lead to personal injury or material damage.



Attention required / Check: please pay special attention to the points described.



Information: provides you with further information relating to the product.

### 2.3 General Safety Information

The frequency inverter was state-of-the-art at the time of delivery and is considered principally safe to operate. The frequency inverter may present certain dangers to personnel, the frequency inverter or other assets of the operator when:

- ◆ non-qualified personnel work on or with the frequency inverter,
- ◆ Operation of the inverter in other mountings or connections, other than described in this manual.
- ◆ the frequency inverter is improperly used.

Then exists danger for:

- ◆ Persons
- ◆ The frequency inverter
- ◆ Other real value of the operator

The installations in which the frequency inverter is incorporated must be designed so that they fulfil their functions when set up correctly and when used in accordance with the instructions in fault-free operation and do not cause any danger to persons. This also applies to the interaction of the frequency inverter with the installation as a whole. In the case of applications in installations with technical safety requirements and with regard to installation, the relevant laws and regulations must be complied with (e.g. EN 57100, EN 60204).



Take additional measures to limit consequences of error functions which can prove to be dangerous for people:

- ◆ other independent devices which safeguard against possible malfunction of the frequency inverter.
- ◆ electrical and non-electrical safety devices (locking or mechanical stops )
- ◆ measures covering the system

Take appropriate measures to see that in case of malfunctioning of frequency inverter there is no material damage.

When work is being carried out on live equipment, the relevant accident prevention regulations must be obeyed.



For reasons of safety and of maintaining documented system data and functions, repairs to the unit or its components are to be carried out only by the manufacturer.

No liability is accepted for inappropriate, incorrect manual or automatic setting of the parameters for the drive.

## 2.4 Operator Responsibilities

Responsibilities of the operator or safety officer:



- ◆ to ensure adherence to all relevant directives, instructions and laws,
- ◆ to ensure that only qualified personnel operate on or with the frequency inverter,
- ◆ to ensure that the operating manual is available to all personnel.
- ◆ to ensure that unqualified personnel do not work with the frequency inverter.
- ◆ The operator is responsible for ensuring that the motor, the inverter and ancillary equipment are installed and connected in accordance with the technical rules applicable in the country in which installation is taking place and with other regulations which are applicable regionally. In this context, special consideration must be given to cable.

## 2.5 Personnel

Only qualified personnel may work on or with the inverter.

## 2.6 Instructions on unpacking, mounting and installation

Check for any transport damage after unpacking the control unit and before the initial start-up.

Check that all plug-in and screwed connections are secure.

Minimum requirements for installation site:

- ◆ The room should be as dust-free as possible (fit filters to control cabinets which have floor fans).
- ◆ The allowed ambient temperature and the relative air humidity must not to be exceeded (if required provide separate cooling).
- ◆ The inverter causes power loss and heats up the environment. Ensure a sufficient distance from heat-sensitive equipment.



- ◆ In the event of contaminated cooling air (dust, fluff, aggressive gases and grease), which might adversely affect the functioning of the frequency inverter, adequate counter-measures must be taken, e.g. separate air feed, installation of filters, regular cleaning, etc.
- ◆ The units are designed for mounting in suitable card racks .
- ◆ The unit must be mounted vertically.
- ◆ Ensure unimpeded access of cooling air and egress of discharged air. Clearances for incoming and outgoing air must be complied with.
- ◆ If the frequency inverter is continuously exposed to oscillation or vibration, vibration absorbers may be required.

### 2.7 Electrical Installation



- ◆ The regulator contains components sensitive to electrostatics. Before installation and service work in the terminal clamp area, the staff must free itself of electrostatic electricity. The discharging can be achieved by touching a grounded metal surface beforehand.
- ◆ To protect the power supply cables, the recommended cable protection fuse is required
- ◆ The motor should be equipped with a temperature sensor . Evaluation can be performed by the FU3AE-04 or a suitable analyser.
- ◆ Control wiring and power cables must always be spatially separated from each other.
- ◆ Set-value inputs must be shielded.
- ◆ Conductor diameters for power supply and motor wiring must be at least 1,5 mm<sup>2</sup>!
- ◆ Observe the current local safety regulations.
- ◆ Use 60/75°C copper wire only
- ◆ Tightening torque for field wiring terminals
- ◆ Use in a pollution degree 2 environment
- ◆ "Use Class 1 wire only" or equivalent
- ◆ "Suitable for use on a circuit capable of delivering not more than 5kA rms symmetrical amperes" for a max. voltage of 480 V.

**Motor over temperature sensing according UL 508C is not provided by the drive or equivalent.**

## 2.8 Information on EMC

In order to warranty electromagnetic compatibility (EMC) in your switch cabinets in an electrically raw environment, the following EMC rules are to be observed during construction and set-up:

- ◆ All metallic parts of the switch cabinet are to be connected flatly and in a well-conducting manner (not lacquer on lacquer!). If necessary, use contact or scraper wafers. The cabinet door is to be connected with as short a circuit as possible via the metal powder tapes (upper, middle, lower).
  - ◆ Signal lines and power cables are to be laid separated from each other in order to avoid coupling intervals. Minimum distance: 20 cm:
  - ◆ Signal lines should be led to the cabinet from only one level, if possible. Unshielded lines from the same electrical circuit (outgoing and return circuit) are to be transposed, if possible.
  - ◆ Contactors, relays and magnetic valves in the switch cabinet, if necessary in the adjacent cabinets, are to be wired with suppressor combinations, e.g. with RC elements, varistors or diodes.
-  ◆ The braiding from signal lines are to be laid two-way (source and target), large-area and well-conducting to a ground<sup>1</sup>. In case of poor potential equalization between shielded connections, an additional balancing network of at least 10 mm<sup>2</sup> must be laid parallel to the braiding to reduce the current.
- ◆ Wiring is not to be laid freely in the cabinet, but should rather lead as tightly as possible to the cabinet frame or to installation plates. This also applies to reserve cables. At least one end of them must be grounded, but preferably both (additional shield effect).
  - ◆ Unnecessary wire lengths are to be avoided. Coupling capacities and coupling inductance's are thereby kept small.
  - ◆ The braiding from leads, such as resolver or incremental tachometer cables, must be laid to the frame grounding. Approximately 2 cm of the insulation is to be removed in the area where the cable is to be led into the frame in order to expose the braided cable. The braided cable may not be damaged while removing the insulation. The cable is to be led at the position where the insulation has been removed by grounded terminals or taut supports.

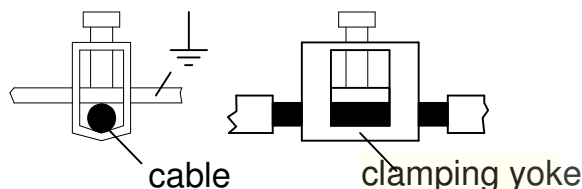

<sup>1</sup>Generally all metallic conducting parts which can be connected to a protective conductor, such as cabinet frames, motor frames, foundation grounding, etc. are designated as a ground.

## 2.9 Operation of the frequency inverter

Operate the frequency inverter only if it is in perfect condition. The permissible conditions of use and output limits must be complied with.



Retrofitting, modifications or conversions of the frequency inverter are **forbidden**. In all such cases, the manufacturer must be consulted.

The frequency inverter is an item of equipment for use in industrial installations. During operation, these items of equipment have dangerous, live components. Consequently, during operation all covers must be fitted to the drive controller, in order to ensure full protection from contact with it.

The modules include electro statically sensitive CMOS und MOS components. Caution must be exercised in respect of electrostatic charges.

## 2.10 Important instructions on protective earthing

Because of the loss currents of the essential mains filter (>3.5 mA) via the protective earthing conductor (PE), according to DIN VDE 0160 the cross-sectional area of the lead-in wire of the protective earth wire to the switch cabinet must be at least 10 mm<sup>2</sup> Cu, or a second protective earth conductor must be laid electrically in parallel.



In the case of higher installed loads, the minimum cross-sectional area of the protective earth conductor must be in a corresponding relation to the cross-section of the outer conductors (see DIN 57100 Part 540).

The loss currents of the filter may be as high as 100 mA. Operation with FI earth leakage circuit breakers is therefore not possible.

## 2.11 Important instructions on routing of wires

Control lines and power cables must always be routed separately with a gap between them. Tacho inputs, set point and analogue control inputs must be laid using shielded cables.



### 3. Technical data

#### 3.1 Technical Data FU3AM

Type		FU3AM
Input voltage range $U_{\text{mains}}$ :	VAC	3x 380 -10% ... 480 +10%;
Input frequency:	Hz	45 ... 66
Nominal input current $I_N$ :	AAC	3x 3
Peak input current:	AAC	3x 5
Connect load:	kVA	2,1
Fuse protection extern <sup>1</sup> :	A	Motor protecting switch (e.g. ABB MS116-4)
24 VDC supply of main contactor:	VDC	24 ±10%
Nominal output voltage $U_a$		0 ... $U_e$
Nominal output current $I_a$ :	AAC	3x 3
Peak output current: $I_{\text{max}}$	AAC	3x 5
Output frequency $f_{\text{out}}$ :	Hz	0 ... 160
Nominal output power S:	kVA	2,1
min. output inductance L:	mH	2
Regulating range with pulse generator (number of gradations > 100)		1:100
Output stage clock frequency:	kHz	4, 8, resp. 16
Installation:		vertical
Ambient temperature:	°C/(°F)	5 ... 40/(41...104)
Atmospheric humidity	%	max. 90 non-condensing!
Connecting terminal:		
Input- and motor connection:		Phoenix Contact PC4HV-7,62
Mains contactor and control terminal:		Wieland 8513BFBK
Parameters:		SUB-D 9-pole (Edge socket connector)
Protection class:		IP 20
Dimensions (WxHxD):	mm	70x235x170
Standards and regulations:		DIN 57110b EN 60204
Spark disturbance		EN 55011b Class A
Approbation / UL-File connection	°C	UL-CSA (E181898) use 60/75°C copper wire only
		Tightening torque for field wiring terminals
		Use in a Pollution degree 2 environment
		“Use Class 1 wire only” or equivalent
		”Suitable for use on a circuit capable of delivering not more than 5kA rms symmetrical amperes” for a max. voltage of 480 V.

Motor over temperature sensing according UL 508C is not provided by the drive or equivalent.



Technical specifications are based on 400 VAC mains input voltage, cycle frequency 4 kHz, 1000 m installation height, unless otherwise stated.

<sup>1</sup> **Note:**

Here is no fuse in the unit for the mains supply. It is essential to provide motor protecting switch, since the unit is not protected otherwise.

### 3.2 Limiting values

UZK (Intermediate circuit voltage)

Heat sink temperature

Air temperature

max. ~ 790 VDC

min. ~ 400 VDC

80°C/(176°F)

70°C/(158°F)

Power loss diagram:

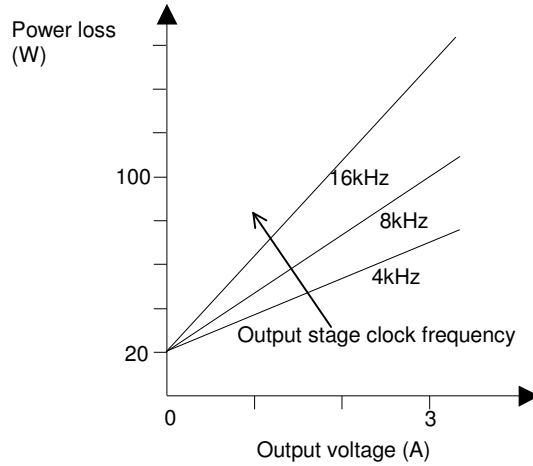

### 3.3 Reduction of Power

At operating altitudes of more than 1000 m above sea level or ambient temperatures over 40°C/104°F, the output of the converters is to be reduced to correspond to the following figures.

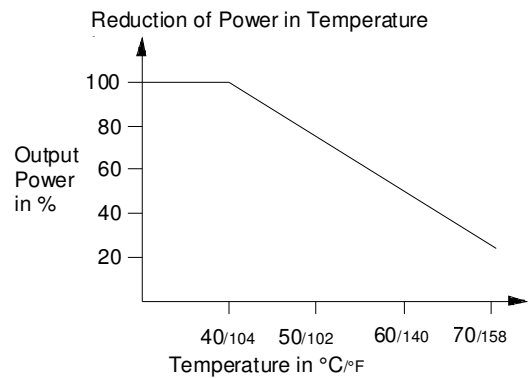
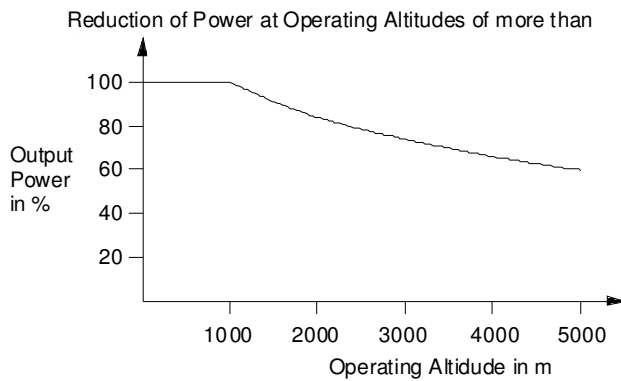

### 3.4 Dimensions

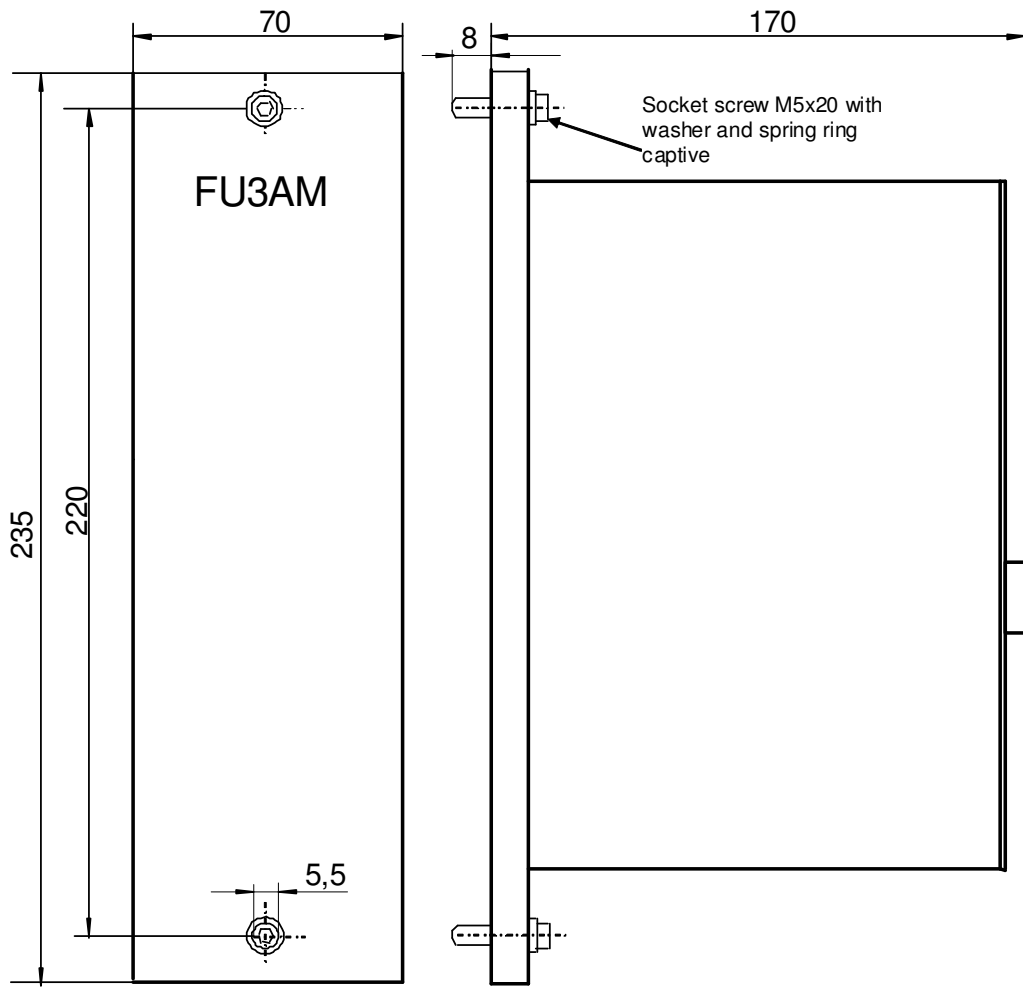

## 4. Description of connection

### 4.1 All connections at a glance

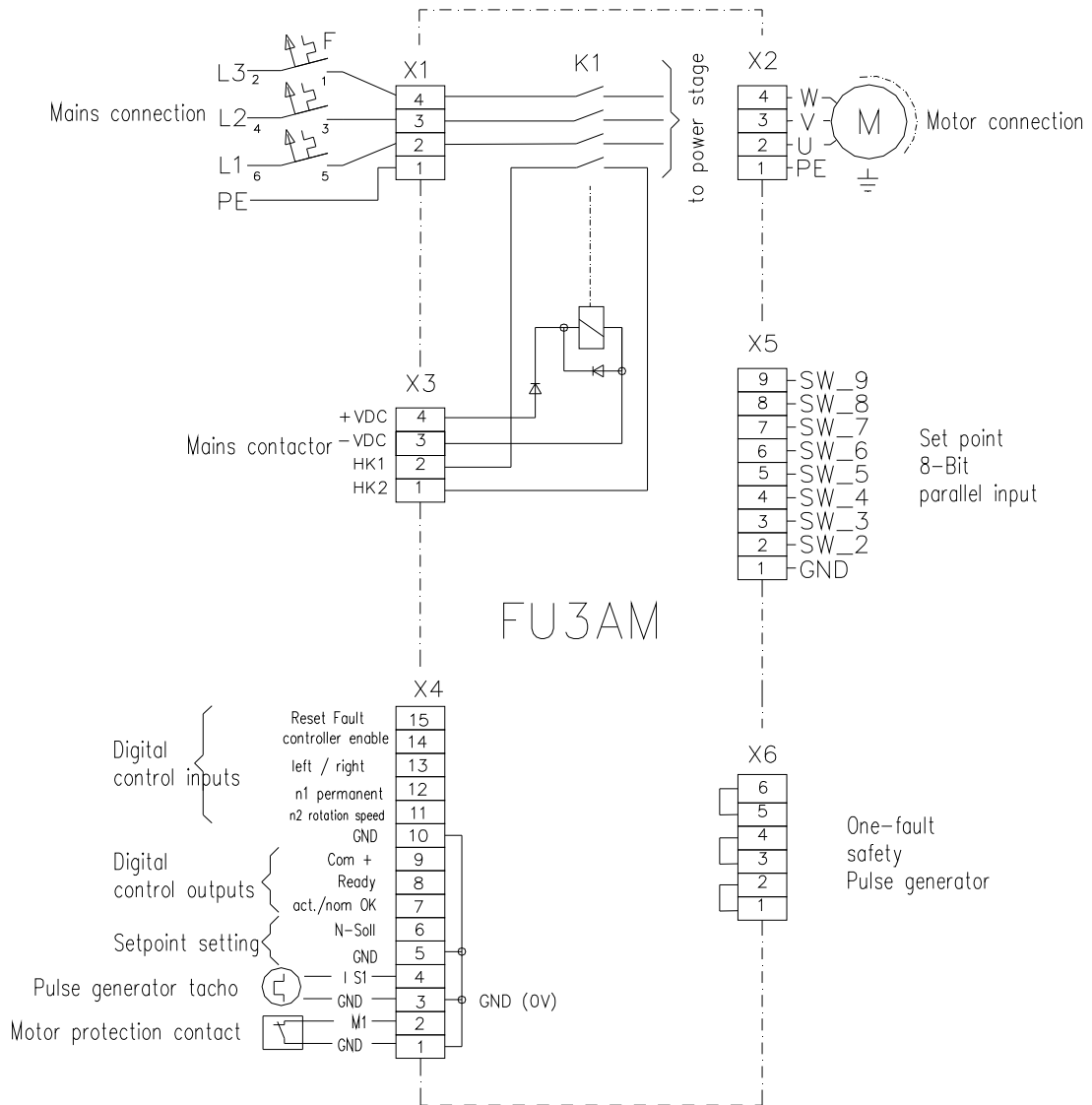

### 4.2 Clamp assembly

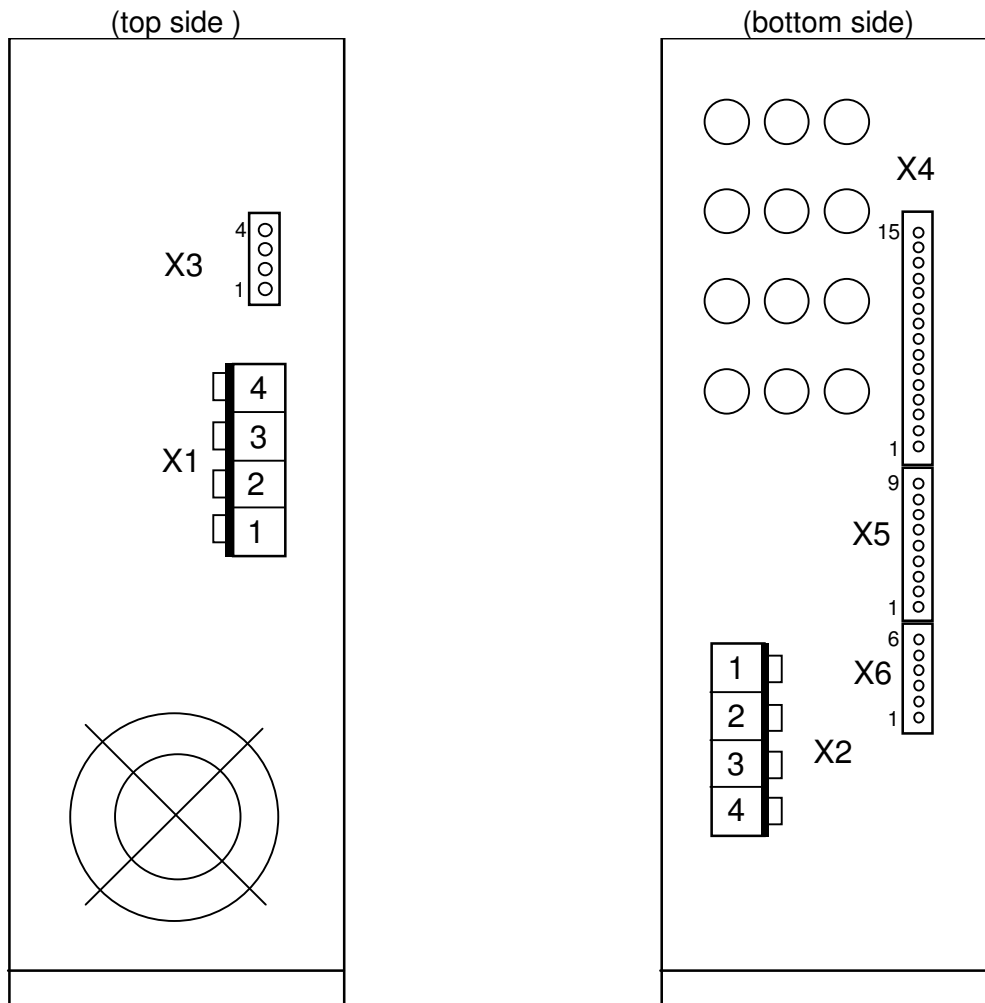

#### Connector description

- X1: Mains connection (see sec: 4.3)
- X2: Motor connection (see sec.: 4.4)
- X3: Mains contactor (see sec.: 4.5)
- X4: Control connection (see sec.: 4.6)
- X5: Set point parallel input (see sec.: 4.7)
- X6: Strapping plug (see sec.: 4.8)



### 4.3 Motor connection plug X1 to top of device

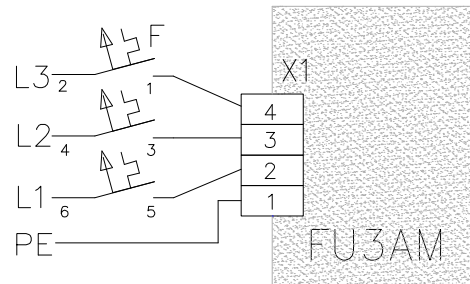
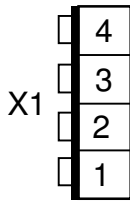

- X1-1 PE
  - X1-2 L1
  - X1-3 L2
  - X1-4 L3
- input voltage

Cable cross section: 1,5 ... 4mm<sup>2</sup> (AWG 15 ... 10)  
Tightening torque: 0,6Nm

### 4.4 Motor connection plug X2 to bottom of device

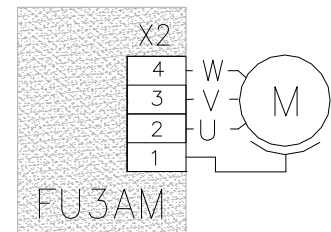
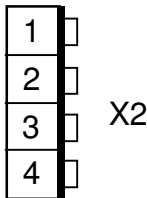

- X2-1 PE
  - X2-2 U
  - X2-3 V
- Motor connection
- Attention!** motor line must always be shielded



- X2-4 W
- Lay screen over a wide area on both sides to PE
- Attention!** do not connect capacitive load. Uncouple motor line through ferrite ring.

Cable cross section: 1,5 ... 4mm<sup>2</sup> (AWG 15 ... 10)  
Tightening torque: 0,6Nm

### 4.5 Connection mains protection X3 to top of device

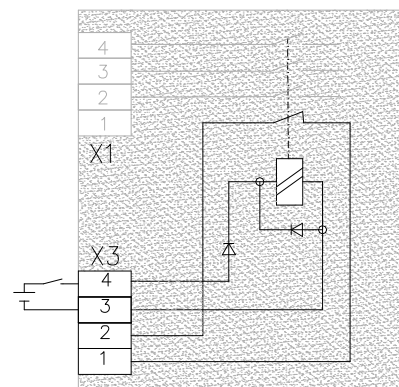
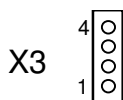

- X3-1 Auxiliary contact
  - X3-2 Auxiliary contact
  - X3-3 0V
  - X3-4 +VDC
- Signal contact (N.O.)  
Signal contact (N.O.)  
Mains protection coil  
Mains protection coil (excitation voltage external)

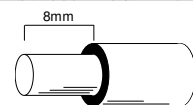

Cable cross section: 0.4 ... 1.5 mm<sup>2</sup> (AWG 21 ... 16) single/fine strand

4.6 Control connection X4

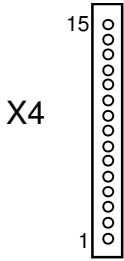

**X4-1 GND**  
**X4-2 Thermo**

Input for motor-thermal contact

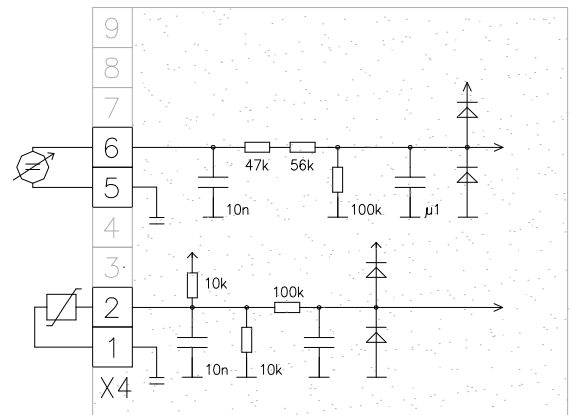

Any thermo-contact (N.C. or N.O.) or thermo-sensor (NTC or PTC) against GND

**X4-5 GND**  
**X4-6 Soll**

Analogue set value (reference GND)

0 ... 10VDC input resistance = 100 kOhm

**X4-3 GND**  
**X4-4 Tacho**

Input f. impulse device tacho (2-wire technology)

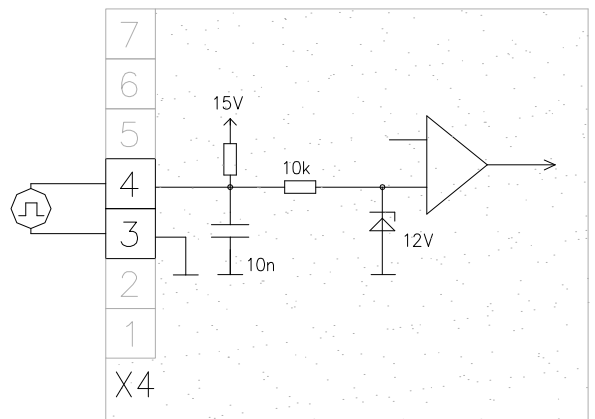

Special impulse device for ANTEK drives

**X4-7 Set-Actual OK** Signalling contact (potential-free): set speed achieved (only in controller mode)  
**X4-8 Ready** Ready signaling contact (potential-free)  
**X4-9 COM+** Reference point for X4-8 and X4-7 (potential-free)

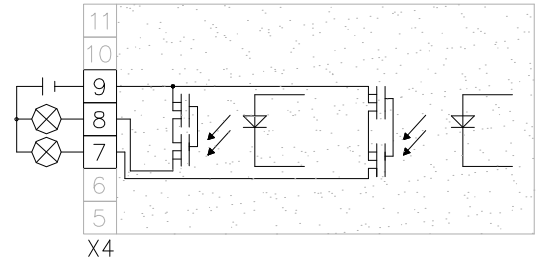

Loading capacity of the signaling outputs: 0.2A, 35VDC or 25VAC

**X4-10 GND** Reference mass for X4-11 ... X4-15  
**X4-11 N2** Fixed speed N2 or digital set value, Bit 1  
**X4-12 N1** Fixed speed N1 or digital set value, Bit 0

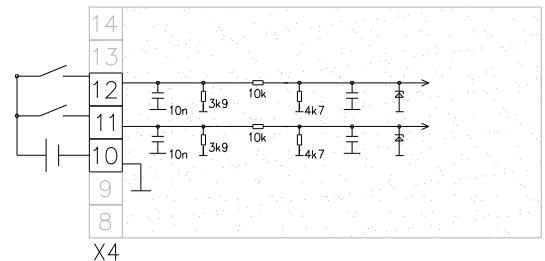

With parameter "source set value" -> "analogue": N1, N2  
 With parameter "source set value" -> "digital": SW\_0, SW\_1

**Fixed set values:**

With the input signals fixed speed #1 and fixed speed #2, 3 fixed speeds through binary coding or the analogue set value specification can be selected.

LOGIC DIAGRAM :	Fixed speed N1	Fixed speed N2
Analogue set value	LOW	LOW
Fixed set value n1	HIGH	LOW
Fixed set value n2	LOW	HIGH
Fixed set value n3	HIGH	HIGH

For parameterisation of the fixed set values, see Section.: 6.2.3

Low = 0 ... +2VDC or open  
 High = +15 ... 30 VDC

**X4-13 L/R** High: counter-clockwise rotation, Low: clockwise rotation  
**X4-14 RF** Controller enable  
**X4-15 Reset** Low-High-Flank = fault reset  
 Low = 0 ... +2VDC or open  
 High = +15 ... 30 VDC

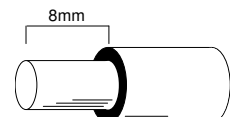

Cable cross section: 0.4 ... 1.5 mm<sup>2</sup> (AWG 21 ... 16) single/fine strand

### 4.7 Digital 10-bit set value parallel input X5

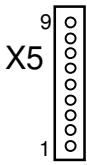

- X5-1 GND**                      Reference potential for digital set value inputs
- X5-2 SW\_2**                    digital set point, Bit 2
- X5-3 SW\_3**                    digital set point, Bit 3
- X5-4 SW\_4**                    digital set point, Bit 4
- X5-5 SW\_5**                    digital set point, Bit 5
- X5-6 SW\_6**                    digital set point, Bit 6
- X5-7 SW\_7**                    digital set point, Bit 7
- X5-8 SW\_8**                    digital set point, Bit 8
- X5-9 SW\_9**                    digital set point, Bit 9

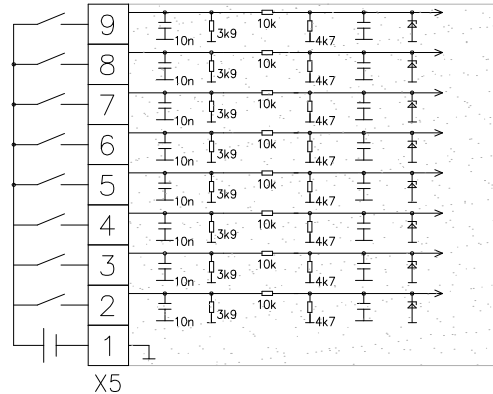

Note: For compatibility reasons the inputs SW\_0 and SW\_1 are to be found on X4-12 and X4-11. If only 8-bits are to be used, SW\_0 and SW\_1 must be on Low (and/or open).

Low = 0 ... +2VDC or open  
 High = +15 ... 30 VDC

Cable cross section: 0.4 ... 1.5 mm<sup>2</sup> (AWG 21 ... 16) single/fine strand

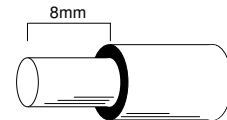

### 4.8 Bridge connector for one-fault safety

Bridge connector for wiring of the one-fault safety

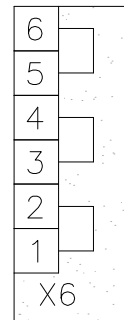

## 5. Commissioning

### 5.1 Switch-on sequence



- Switch on Mains voltage and Mains contactor
- first time assign parameters to suit the respective conditions.
- Specify controller enable and set point



**Caution!** On the control plugs X4 and X5, first must the voltage switched on, after the equipment is switched on, that means after the main voltage and contactors become switched on and the equipment reports „ready“.

### 5.2 Display

The 7-segment display displays the instantaneous status of the unit. (The status of the unit can also be ascertained using the “UniDesk“ operating software).

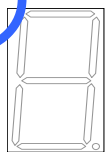

Display off: control voltage has failed or is too low. Unit is non-operational.

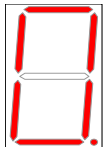

0- not ready: no fault, but mains voltage is not enough present. In this condition, the inverter waits for the built up of the main voltage.

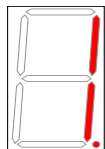

1- Ready: no fault. The drive can be started immediately.

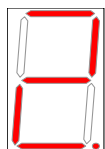

2- Clockwise rotation: no fault. The inverter generates a clockwise rotating field

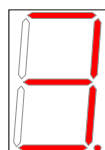

3- Anti-clockwise rotation: no fault. The inverter generates an anti-clockwise rotating field.

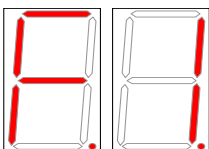

F1- Undervoltage mains: the intermediate circuit voltage has dropped below a critical value. (This fault is triggered only during controller enable) Drive switched off. Check power supply. (3.1)

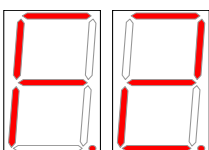

F2- Overvoltage : the intermediate circuit voltage has exceeded a critical value. Drive switched off. Check power supply, check motor braking energy. (3.1)

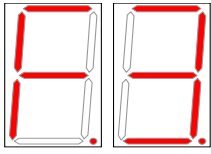

F3- Overtemperature of the heat sink or internal air: the inverter's heat sink or the internal air has become too hot. Drive switched off. Ensure that the inverter is adequately cooled.

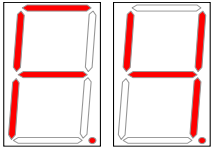

F4- Overcurrent: Either the set peak current has been briefly exceeded or the continuous current has been exceeded for some time. Drive switched off. Check the load on the motor.

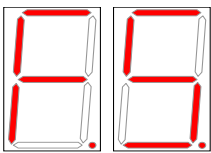

F5- Output stage: a fault has occurred in the power stage of the inverter. Drive switched off. If this fault occurs repeatedly, please inform the manufacturer. Control wiring and motor.

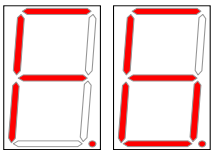

F6- Processor. A fault has occurred in the inverter's microprocessor. Drive switched off. If this fault occurs repeatedly, please inform the manufacturer.

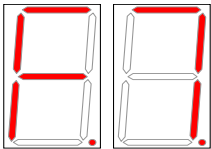

F7- Overtemperature motor: motor has become too hot. Drive switched off. Check the load on the motor, ensure motor is cooled, and check parameters.

## 6. Service information

### 6.1 Summary of parameters

No.	Parameter	Explanation
30	Mode	
31	switching frequency	Cycle frequency output stage
32	U-0	Output voltage
33	U-50	Voltage at 50Hz
34	f-nom	Output frequency with max. set value specification
35	Offset	Offset set value
36	Mult. of speed set value	Multiplier for set value
37	N1	fixed set value 1
38	N2	fixed set value 2
39	N3	fixed set value 3
40	tH	Set value ramp during acceleration
41	tR	Set value ramp during braking
42	n-nom	Nominal speed for speed controller mode
43	number of poles	Number of motor poles
44	Number of gradations	Number of gradations for pulse generator
45	t-n-act	Speed actual value filter
46	KPn	KP- speed controller
47	KIn	KI- speed controller
48	regulator range	Influence of speed controller
49	max difference	Threshold nom.-act. -monitoring
50	t-difference	Delay signal contact Nom.-Act monitoring
51	I-peak	Current peak
52	I-Cont.	Continuous current
53	t-I-act	actual value filter
54	t-I-red	Transit time current threshold
55	autoreset	0=no automatic reset
57	Temp. Mot.	threshold motor temperature
58	Mot.-Sens.	Temperature sensor motor
65	source set value	Set value specification over analogue voltage/fixed set value or over digital inputs SW_0 ... SW_9

## 6.2 Configuration und useful information on parameters



All parameters may be changed only when the controller is not enabled!

### 6.2.1 Mode

#### 6.2.1.1 Static

The inverter operated controlled; i.e., depending on the input set value an output voltage is output according to the characteristic curve (see Section 6.2.2).

#### 6.2.1.2 Controller mode



For controller mode operation feedback with the pulse generator is required. Over parameters n-nominal, number of poles, the motor and the desired nominal speed is set. The parameter number of strokes defines the sensor resolution of the attached impulse device for speed feed-back, The control properties can be influenced with the parameters KPn (proportional part) and KIn (integral part).

If the feedback jitters, i.e. indicates speed fluctuations which are not present, these can be smoothed by means of the speed actual value filter. The parameter 't-n-Act.' specifies the time constant for this filter.



The speed controller's control variable affects the inverter's characteristic curve, but excessive displacements of the characteristic curve must be avoided; otherwise the motor may exceed its breakdown torque. The limit is imposed by means of the 'Influence' parameter.

The two parameters 'Threshold Nom.-Act.' and 't-Nom.-Act' relate to the 'Nom.-Act. OK' signal contact. The maximum permissible speed deviation from the set point is specified by 'Threshold Nom.-Act.'; 't-Nom.-Act.' defines how long an excessively high speed deviation is tolerated (e.g. during start-up). In the static mode, the signal output is permanently closed.

#### 6.2.1.3 f-Takt

The pulse frequency of output stage is to adjust by the parameter f-Takt.

Lower cycle frequency	=	better device efficiency
Higher cycle frequency	=	lower current ripple
	=	quieter running



### 6.2.2 Characteristic curve

The frequency inverter's characteristic curve must be adapted to the connected motor:

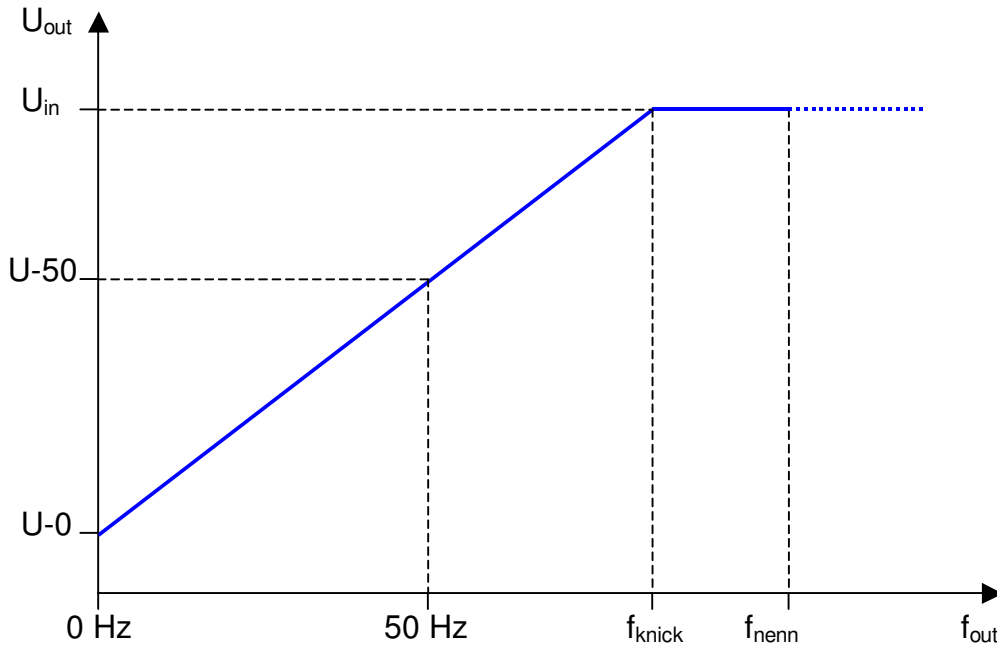

The diagram shows the relationship between output frequency ( $f_{out}$ ) and output voltage ( $U_{out}$ ). The position and steepness of the characteristic curve is determined by the two parameters U-0 (voltage when  $f_{out}=0\text{Hz}$ , also termed Boost) and U-50 (voltage when  $f_{out}=50\text{Hz}$ , can as a rule be taken from the motor rating plate).

Setting U-0 high results in improved start-up behaviour, but also causes the motor to heat up more.



This characteristic curve is continued in linear fashion until it is limited by the available input voltage ( $U_{in}$ ). At this point, the kink frequency occurs ( $f_{kink}$ ).

Above the kink, the motor's nominal moment is no longer available (because of physical limitations).

### 6.2.3 Set point adaptation, fixed set points and ramps

Adaptation of analogue set-point is possible by means of the parameters 'Offset' and 'Mult. N-Nom.'. The 'Offset' parameter offsets the set point (e.g. for zero balancing); the 'Mult N-Act.' represents the evaluation factor for the set point.

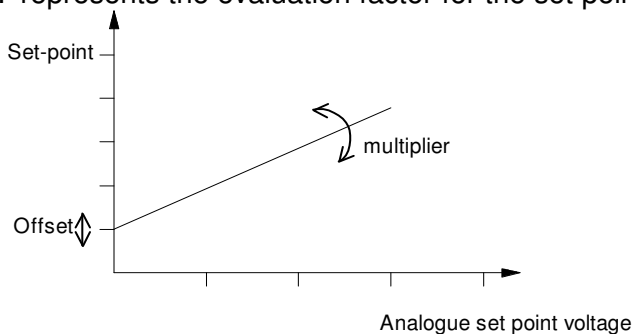

It must be noted that the physical range of the set point voltage remains restricted to 0...10V. Fixed set points are programmed by parameters '#1', '#2' and '#3'. See also section 4.6.

There is also the possibility of specifying the set value digitally (see also Section 4.7). Over the 8 parallel input bits a value between 0 (0%) and 255 (100%) can be specified. The bit pattern at the input is assumed directly (without handshake).

The run-up and run-down ramps are specified in the parameters 'tH' and 'tR'. They define the time (in seconds) for acceleration from 0 to 'f-Nom' and vice versa.

#### **6.2.4 Automatic reset**

The automatic reset function resets the device automatically after the occurrence of a fault and after expiration of a predetermined waiting time. 0 = automatic reset off.

#### **6.2.5 Motor temperature monitoring**

The device can evaluate different sensors for motor temperature measurement. Setting over the parameter Temp.Mot. or Mot-Sens.

#### **6.2.6 Fan control**

Each fan is a wear part, especially in contaminated environments (dust). If the heat sink fan is only activated when the natural convection no longer suffices, this will extend the life significantly. The switching thresholds are fixed at the factory.

#### **6.2.7 Operating hours counter**

The operating hours counter counts the processor operating time with a resolution of 0.01 hours. The operating hours counter can be deleted only through a hardware intervention (i.e., from the factory). If the axis goes into fault, the operating hours counter generally is saved with the fault, thus a clear allocation of fault time is ensured.

#### **6.2.8 Overcurrent cut-off**

The motor current is continuously monitored. To screen out errors in the measurement, the measurement passes through a filter. The filter construction is set with parameter t-I-Actual. If the motor current exceeds the peak current (I-max), the device is cut off.

If the average motor current exceeds the continuous current limit (I-Cont) over a certain time, the device is cut off. The time constant is set with the parameter t-I-red.

## 7. Finding and eliminating faults

### 7.1 Resetting faults

- ◆ Control voltages ON/OFF
- ◆ Pos. edge on control input "Reset fault"

### 7.2 Possible causes of faults

A number of possible causes of faults are listed in the table below.

<b>Fault</b>	<b>Possible cause</b>	<b>Remedy</b>
Display off	Mains voltage absent	Check voltage
Display indicates 0	Mains voltage too low	Check voltage
Display indicates fault code	See section. 5.2	See section. 5.2
Motor not running, even though display indicates 2 (clockwise) or 3 (anti-clockwise)	Set point too low	Specify set point
	Wiring fault	Check wiring (esp. motor phases)
	U-0 to low (at low speeds)	Correct U-0
Drive controller oscillates (speed controller mode)	Controller set incorrectly	Optimise KPn, Kin and t-n-Act. if necessary
Motor runs out of true	EMC	Link reference earth of analogue and digital inputs respectively
		Screening of analogue and digital inputs, large-area earthing of sensor signals and motor cable

If you return the unit for testing or repair, please provide the following information:

- ◆ type of fault
- ◆ accompanying circumstances
- ◆ suspected cause of the fault
- ◆ unusual preceding events

## 8. Operating software

### 8.1 UniDesk

In order to be able to parameterise and monitor the frequency inverter FU3AE-04, ANTEK UniDesk monitor software is required.

The current version of UniDesk is available for downloading at [www.antek-online.de](http://www.antek-online.de)

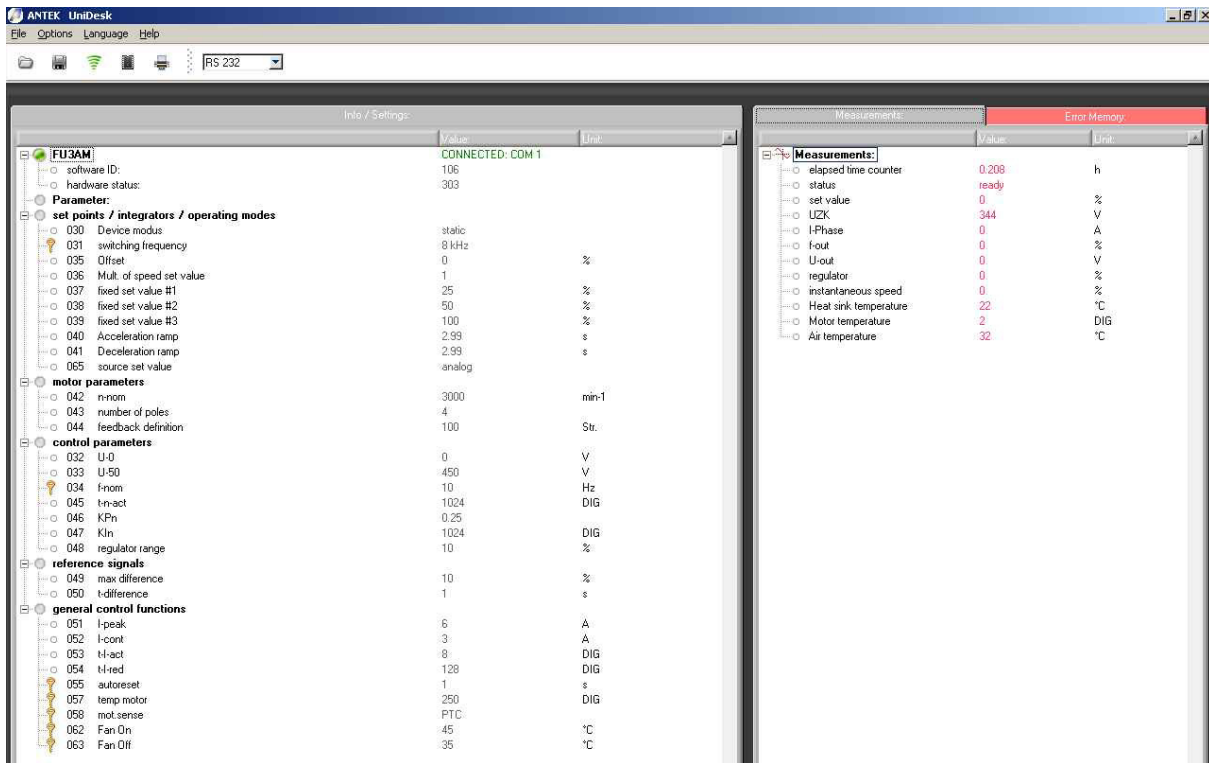

More information on UniDesk is found in the file *UniDesk\_Beschreibung.pdf*, which is included in the program package. The free Acrobat Reader ([www.adobe.de/acrobat](http://www.adobe.de/acrobat)) is required to read the file.

### 8.2 Serial interface

Communication from UniDesk and the controller takes place across a standard RS232 cable (DTE – DCE, not crossed) with 9-pole Sub-D connectors.

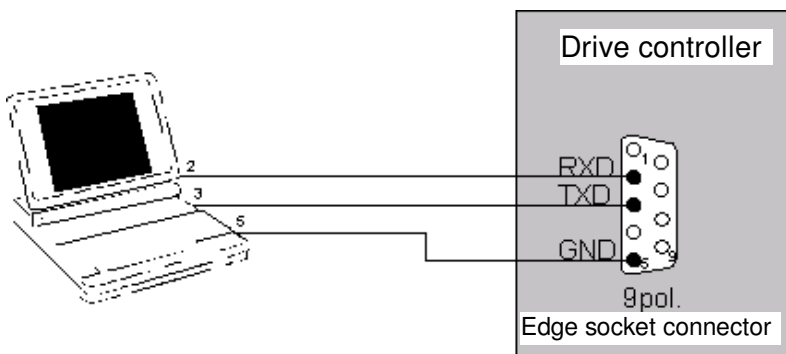

## 9. Revision index

### 9.1 Documentation

Document name	Revision
R0086DE.doc	Original version (brief description)
R0086aDE.doc	Cap. 5.1: Caution switching on sequence Cap. 8.1: Download note
R0086bDE.doc	Cap. 4.6.: Drawing (X4-10,11,12) correction Cap. 8.1.: Update download link
R0086cDE.doc	Cap. 9: Revision index inserted
R0086dDE.doc	Cap. 4.6, 4.7: Digital 10-bit set value

### 9.2 Devise

Firm-ware	HW-Stat.	Para-meter	Revision
1.04	0301		Original version
1.05	0302		<ul style="list-style-type: none"> <li>HW-Workaround because of Infineon-Fault (Errata Sheet C508-4E, ES-AA, AA, Release 1.8, Item OTP.1) Residual voltage before switching on.</li> <li>SW: Correction standardisation U/f characteristic for high frequencies</li> </ul>
1.06	0303		<ul style="list-style-type: none"> <li>Digital 10-bit set value</li> </ul>

## 10. Index

- Accident prevention regulations 8
- Act./Nom. monitoring 5
- Analogue set value 18, 19
- Anti-clockwise rotating field 22
- Boost 27
- Card rack 9
- Characteristic curve 26, 27
- Clockwise rotating field 22
- Commissioning 22
- control cabinet 5
- Control voltage 22, 29
- Controller enable 22
- Controller mode 26
- Display 22, 29
- Electrostatic 11
- EMC 29
- Fault 22, 29
- feedback 5, 26
- Fixed set point 28
- Fixed set value 19
- Fixed speed** 19
- Frequency converter 5, 7, 9, 11, 30
- Fuse 12
- Influence 26
- Instructions 8
- Kink frequency 27
- Laws 7
- Loss current 11
- Mains voltage 22, 29
- Motor 8, 9, 24, 26, 27, 29
- Motor cable 29
- Nominal moment 27
- Operating software 22, 30
- Operator 8
- Oscillation 9
- Output frequency 27
- Output stage 5, 24
- Output voltage 27
- Overcurrent 24
- Overload-proof protection 5
- Overtemperature 24
- Overvoltage 22
- Personnel 8
- Phase current monitoring 5
- Potential-free electronics 5
- Power loss 9
- Processor 24
- Protective earth 11
- Protective earthing conductor 11
- Pulse generator 26
- Ramp 28
- Regulations 7, 8
- Safety 8
- screen 17
- Set point 11, 22, 26, 27, 29
- Set point adaptation 27
- Switch cabinet 11
- Temperature sensor 9
- Tightening torque 17
- Undervoltage 22
- UniDesk 22, 30
- Vibration 9